

Name : _____

Score : _____

Teacher : _____

Date : _____

Multi-Step Problems

Find the variable side. Round the intermediate and final values to the nearest tenth.

1) $t = \underline{\hspace{2cm}}$ ft

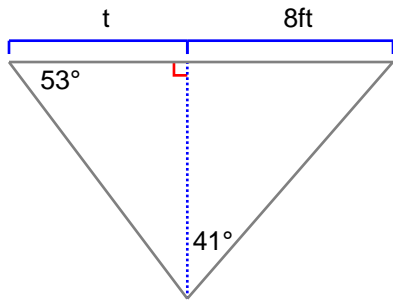

2) $s = \underline{\hspace{2cm}}$ ft

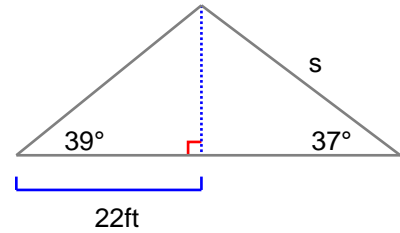

3) $n = \underline{\hspace{2cm}}$ ft

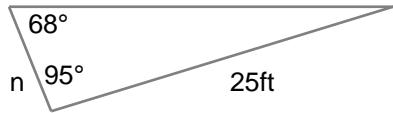

4) $x = \underline{\hspace{2cm}}$ ft

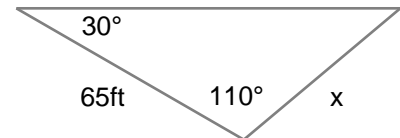

Find the area of each triangle. Round the intermediate and final values to the nearest tenth.

5) Area = $\underline{\hspace{2cm}}$ ft²



6) Area = $\underline{\hspace{2cm}}$ ft²

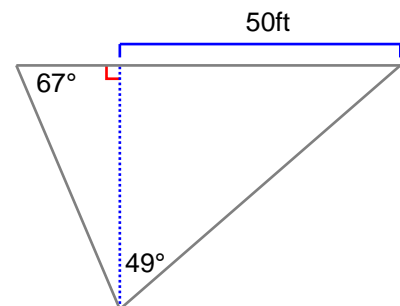

Name : _____

Score : _____

Teacher : _____

Date : _____

Multi-Step Problems

Find the variable side. Round the intermediate and final values to the nearest tenth.

1) $t = \underline{6.9}$ ft

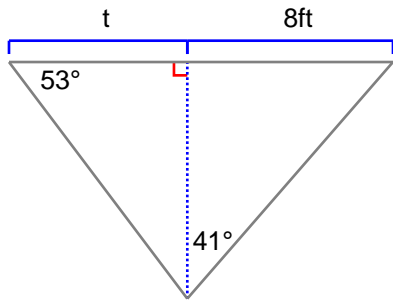

2) $s = \underline{29.6}$ ft

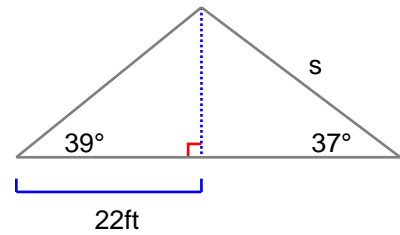

3) $n = \underline{7.9}$ ft

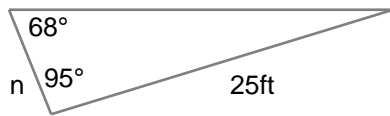

4) $x = \underline{50.6}$ ft

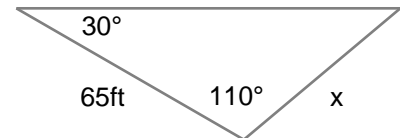

Find the area of each triangle. Round the intermediate and final values to the nearest tenth.

5) Area = $\underline{1557.9}$ ft²



6) Area = $\underline{1487.6}$ ft²

